



## RESIDENTIAL TANKLESS WATER HEATER

*Introducing Lochinvar's XCalibur premium condensing gas tankless water heaters, delivering robust, on-demand performance and the flexibility to install in practically any residential setting.*

### PREMIUM CONDENSING GAS MODELS

X3<sup>®</sup> SCALE PREVENTION TECHNOLOGY (PATENT PENDING)

HEAVY DUTY STAINLESS-STEEL HEAT EXCHANGER DESIGN

INTEGRATED RECIRCULATION PUMP & DISPLAY

ULTIMATE FLEXIBILITY - EASE OF INSTALLATION & SERVICEABILITY

DIRECT VENT DESIGN

- 2" PVC up to 75'
- 3" PVC up to 150'

PERFORMANCE & EFFICIENCY

- 160,000, 180,000, 199,000 BTU/HR
- 9,000 BTU MIN. INPUT
- 22:1 TURNDOWN RATIO (199K CONFIGURATIONS)
- 0.95 UEF (ENERGY STAR<sup>®</sup> CERTIFIED)



LTHR - 160X3, LTHR - 180X3,  
LTHR - 199X3  
(with X3 prevention cartridge)



LTHR - 160X3, LTHR - 180X3,  
LTHR - 199X3  
(with optional outdoor kit)



LTHR - 160M, LTHR - 180M,  
LTHR - 199M (with bypass manifold)



**Lochinvar**<sup>®</sup>  
HIGH EFFICIENCY BOILERS & WATER HEATERS

### X3 SCALE PREVENTION TECHNOLOGY (PATENT PENDING)

Integrated into all X3 models; optional accessory for Bypass Manifold (M) models and can be added at any time

No annual descaling required with X3

No scale buildup means the heater maintains like-new performance longer

Extends life up to three times versus unprotected unit

### HEAVY DUTY STAINLESS-STEEL HEAT EXCHANGER DESIGN (Patented)

Single stainless steel, heavy-duty heat exchanger design eliminates most internal welds and improves overall efficiency

More resilient to scale buildup and corrosion

### INTEGRATED RECIRCULATION PUMP & DISPLAY

Integrated recirculation pump

Built-in Control Display to set and review recirc schedules, status, and error codes

Optional remote activation (CA Title 24) kits available

### PERFORMANCE & EFFICIENCY

Max flow rate 10.5 GPM, 0.4 GPM activation; 0.26 GPM for continuous fire

Ultra-Low NOx emissions - Complies with SCAQMD Rule 1146.2\*

Elevation: Certified from Sea Level to 10,100 ft.

Sound Level: 50.3 dB (Based on factory settings)

### ULTIMATE FLEXIBILITY - EASE OF INSTALLATION & SERVICEABILITY

Universal indoor or outdoor installation; Outdoor Vent Cap Kit sold separately

Field convertible from Natural Gas to Liquid Propane, kit included

Wall-mount design saves valuable space; hanging bracket and hardware included

½" Gas Line or larger

Flip Down Hinged Control Board for easy access

Pressure Relief Valve included with X3 models

Outdoor rated power cord standard on every unit

Cascade up to 12 units with single cable per heater, cable included

Temperature setting: 100°F to 140; Factory default 120°F

Approved for installation in manufactured homes

Electronic Ignition System

Internal freeze protection system to -5°F +

Power Supply: 120V, 50Hz/60Hz, <5a

### DIRECT VENT DESIGN

Exhaust venting, 2" PVC up to 75'; 3" PVC up to 150'

Cat. IV venting may be used

Flexible venting with PVC, CPVC, Polypropylene, or ABS Pipe (solid core only)

### WARRANTY

No hard water exclusions on X3 models; exclusions apply to M models

15-year limited warranty on heat exchanger in residential applications

5-year limited warranty on all parts in residential applications



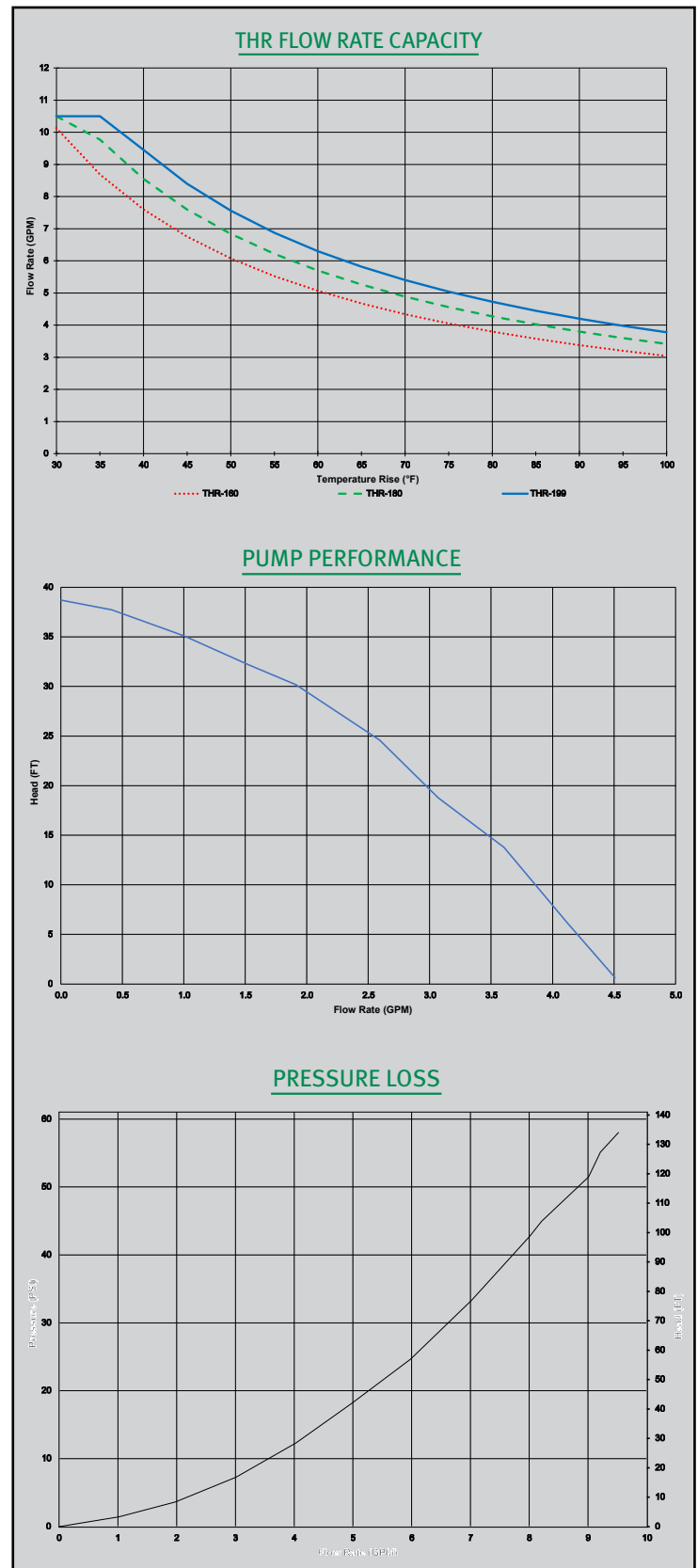





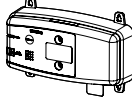
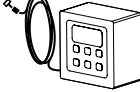

1-year limited warranty on heat exchanger and parts in commercial applications

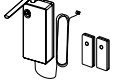
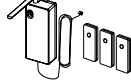

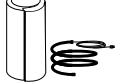
+ Internal freeze protection for heater only; both Bypass cartridge and X3 cartridge require anti-freeze kits sold separately.

\*Ultra Low NOx - Complies with SCAQMD Rule 1146.2 and other air quality management districts with similar NG NOx emission requirements of 14ng/J or 20 ppm. Complies with SJVAPCD Rule 4308 and other air quality management districts with similar LP NOx emission requirements of 77ppm.

## ACCESSORIES

Item		Description
X3 Cartridge 100368986		Add to an M model heater to prevent scale buildup and eliminate the need for annual descaling maintenance.
Wi-Fi Module Kit 100371922		Wi-Fi Module for electronically connecting tankless water heaters to the internet and adapter to connect to the water heater. <ul style="list-style-type: none"> <li>• Module (1x)</li> <li>• Cable (1x)</li> <li>• Adapter (1x)</li> </ul>
Remote Temperature Controller 100371898		Remote Temperature Controller with 10' (3 m) cable.
Communication Cable - 10' (3 m) 100371889		Replacement Communication Cable for Remote Temperature Controller or WIFI Module, or On-Demand Receiver, 10' (3 m).
Communication Cable - 32' (10 m) 100371900		Extended Communication Cable for Remote Temperature Controller or WIFI Module, or On-Demand Receiver, 32' (10 m).
Remote Recirculation Kit - Two Buttons 100371920		Remote Recirculation Kit engages heater and recirculation at a touch of a button for on-demand hot water. Kit contains: Receiver (1x), Buttons (x2)
Remote Recirculation Kit - Three Buttons 100371921		Remote Recirculation Kit engages heater and recirculation at a touch of a button for on-demand hot water. Kit contains: Receiver (1x), Buttons (x3)
Individual Spare Button 100371913		Add more Remote Recirculation Buttons to a system as needed. Add up to a maximum of 30 buttons.
X3 Freeze Protection (X3 Models) 100325654		X3 Cartridge Freeze Protection can add an extra layer of freeze protection to external SCM cartridge. Cartridge not protected by heater's internal freeze protection.
Bypass Freeze Protection (M Models) 100371918		Bypass Freeze Protection can add an extra layer of freeze protection to external Bypass cartridge. Cartridge not protected by heater's internal freeze protection.
Pipe Cover 100374697		Pipe Cover protects plumbing connections to the heater while improving the appearance of the installation. Affixes to bottom of heater.
Neutralizer Assembly Kit 100112159		Neutralizer Assembly neutralizes the condensate (acidic water) that forms in the heat exchanger of the water heater. It connects to the condensate drain port of the water heater by using connectors included with the neutralizer kit.
Outdoor Vent Cap Kit 100369060		Vent cap kit and accessories for installing the tankless heater outdoors. Kit contains: <ul style="list-style-type: none"> <li>• Vent Cap (1x)</li> <li>• User Interface Overlay (1x)</li> </ul>
Isolation Valve Kit with Pressure Relief Valve 100112156		Isolation Valve supports routine maintenance and allows for draining and flushing the heater; whereas, the Pressure Relief Valve, as the name implies, serves to limit internal pressure in the system. Not necessary for X3 models. Check local codes for applicability.
Cross Over Valve Kit 100327167		For plumbing systems without a dedicated return line necessary for recirculation system functionality. Install at the faucet furthest from the hot water heater.

# DIMENSIONS AND SPECIFICATIONS

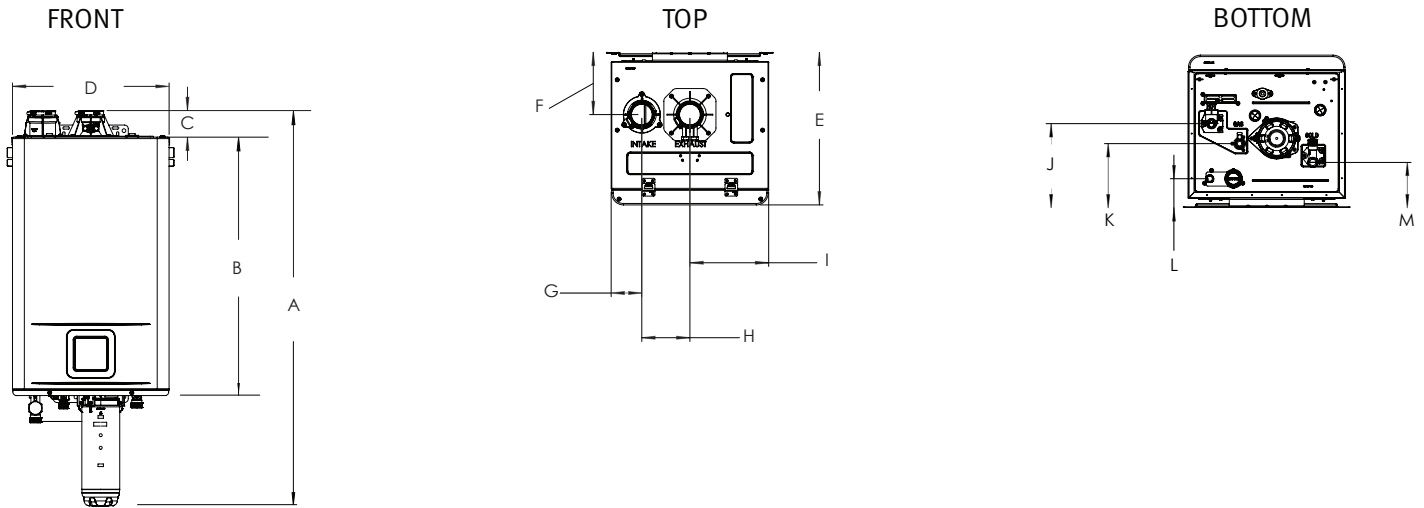

## XCALIBUR PREMIUM CONDENSING GAS TANKLESS DIMENSIONS AND SPECIFICATIONS

Model Number*	X3 Scale Prevention Technology	Gas Con. Input Min. BTU/HR	Gas Con. Input Max. BTU/HR	Max. GPM**	Activation GPM	Continuous Fire GPM	Water Pressure PSI Min-Max^	Supply Gas Pressure (NG)		Supply Gas Pressure (LP)		Hot/Cold Conn.	Gas Conn.	Shipping Dimensions****			Ship Weight (lbs.)
								Min. in W.C. (kPa)	Max in W.C. (kPa)	Min. in W.C. (kPa)	Max in W.C. (kPa)			H	W	D	
LTHR-160M	Optional	9000	160,000	10.5	0.4	0.26	15-150	3.5 (0.9)	10.5 (2.6)	8.0 (2)	13.0 (3.2)	3/4" NPT	1/2" NPT	20-3/4"	22-1/4"	40"	125
LTHR-160X3	Integrated	9000	160,000	10.5	0.4	0.26	15-150	3.5 (0.9)	10.5 (2.6)	8.0 (2)	13.0 (3.2)	3/4" NPT	1/2" NPT	20-3/4"	22-1/4"	40"	125
LTHR-180M	Optional	9000	180,000	10.5	0.4	0.26	15-150	3.5 (0.9)	10.5 (2.6)	8.0 (2)	13.0 (3.2)	3/4" NPT	1/2" NPT	20-3/4"	22-1/4"	40"	125
LTHR-180X3	Integrated	9000	180,000	10.5	0.4	0.26	15-150	3.5 (0.9)	10.5 (2.6)	8.0 (2)	13.0 (3.2)	3/4" NPT	1/2" NPT	20-3/4"	22-1/4"	40"	125
LTHR-199M	Optional	9000	199,000	10.5	0.4	0.26	15-150	3.5 (0.9)	10.5 (2.6)	8.0 (2)	13.0 (3.2)	3/4" NPT	1/2" NPT	20-3/4"	22-1/4"	40"	125
LTHR-199X3	Integrated	9000	199,000	10.5	0.4	0.26	15-150	3.5 (0.9)	10.5 (2.6)	8.0 (2)	13.0 (3.2)	3/4" NPT	1/2" NPT	20-3/4"	22-1/4"	40"	125

Model Number*	A***	B	C	D	E	F	G	H	I	J	K	L	M
LTHR-160M	33-3/4"	26-3/4"	2-3/4"	16-1/2"	16"	7"	3-1/4"	5"	8-1/4"	9"	6-3/4"	3"	4-3/4"
LTHR-160X3	44-1/2"	26-3/4"	2-3/4"	16-1/2"	16"	7"	3-1/4"	5"	8-1/4"	9"	6-3/4"	3"	4-3/4"
LTHR-180M	33-3/4"	26-3/4"	2-3/4"	16-1/2"	16"	7"	3-1/4"	5"	8-1/4"	9"	6-3/4"	3"	4-3/4"
LTHR-180X3	44-1/2"	26-3/4"	2-3/4"	16-1/2"	16"	7"	3-1/4"	5"	8-1/4"	9"	6-3/4"	3"	4-3/4"
LTHR-199M	33-3/4"	26-3/4"	2-3/4"	16-1/2"	16"	7"	3-1/4"	5"	8-1/4"	9"	6-3/4"	3"	4-3/4"
LTHR-199X3	44-1/2"	26-3/4"	2-3/4"	16-1/2"	16"	7"	3-1/4"	5"	8-1/4"	9"	6-3/4"	3"	4-3/4"

All models are Energy Star® qualified.  
 \* Universal install; outdoor installation requires outdoor vent cap kit (Part No. 100369060) sold separately; \*\* Current numbers based on factory settings; \*\*\*Height from flue collar to bottom of cartridge or manifold; M models with Bypass Manifold cartridge, X3 models with Scale Control Media cartridge. \*\*\*\*Packaged and shipped on unit back.

^ 40 PSI Recommended for Maximum Flow

Included with Heater: Manual, Pressure Relief Valve (X3 models only), Wall Mounting Bracket and Hardware, Vent Port Screws, Cascading Cable, Fuel Conversion Kit, Bird Screens

For technical information call 800-722-2101. Lochinvar, LLC reserves the right to make product changes or improvements without prior notice.